



深圳市中顺半导体照明有限公司

— Shenzhen Zhongshun Semiconductor Lighting Co., Ltd. —

Specification 规格书

Customer Name: _____

客户名称

Customer P/N: _____

客户品号

Factory Model: _____ Z-L2835*****P3

公司型号

Sending Date: _____

呈送日期

R&D 研发规格书 Sample 样品规格书 Product 产品规格书

Customer Approval

客户审核

ZS Approval

中顺审核

Approval

核准

Audit

确认

Confirmation

制作

Approval

核准

Audit

确认

Confirmation

制作

黄山虎

邓文锋

吴顺

Qualified

授受

Disqualified

不接受

Date:

日期: 2023.02.13



Address: MeiXun Technology Park, No. 19, Jinxiu Middle Road, Pingshan District, Shenzhen

地址: 广东省深圳市坪山区锦绣中路 19 号美讯科技园

Tel/联系电话: 400-088-2835 Web/网址: www.zsled.com.cn



LM-80

EN 62471



Contents 目录

Version history 修订履历.....	3
Features 特征.....	4
Application 应用.....	4
Package dimension 封装尺寸.....	4
Product number explanation 产品编码说明.....	5
Table of Color 发光颜色.....	5
Table of Power 功率.....	5
Table of specifications 规格表.....	5
Absolute maximum ratings 绝对最大额定值.....	5
Electrical-Optical characteristics 电性与光学特性.....	6
Luminous Intensity Rank 亮度等级.....	6
Forward voltage rank 电压等级.....	6
Wavelength Rank 波长等级.....	7
CIE chromaticity diagram 色区图.....	7
Typical optical characteristics curves 典型光学特性曲线.....	8
Reliability test items and conditions 信赖性测试项目及条件.....	9
Label dxplanation 标签说明.....	10
Reel dimensions 卷盘尺寸.....	10
Carrier tape dimensions 载带尺寸.....	11
Moisture resistant packing process 防潮包装过程.....	11
Precautions for use over-current-proof 通电使用时的注意事项.....	12
Storage 存储.....	12
Soldering condition 焊接条件.....	12
Soldering iron 烙铁焊接.....	13
Repairing 返修.....	13
Cautions 使用注意事项.....	13

Features (特征)

1. PLCC-2 package (PLCC-2 封装)
2. Wide viewing angle (大角度发光)
3. RoHS compliant (符合 RoHS 标准)
4. Package: 1000pcs/reel (包装每卷 1000PCS)

Application (应用)

1. keyboard Backlight (键盘背光)
2. Optical indicator (光学指示)
3. Switch Lights (开关照明)
4. Decorative and Entertainment Lighting (装饰与娱乐照明)

Package Dimension (封装尺寸)

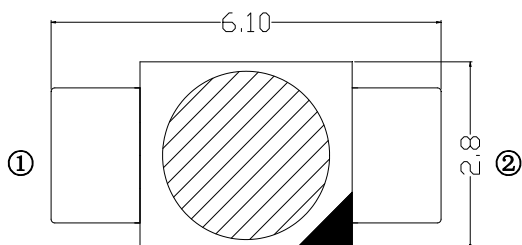

1-1 Top view 正视图

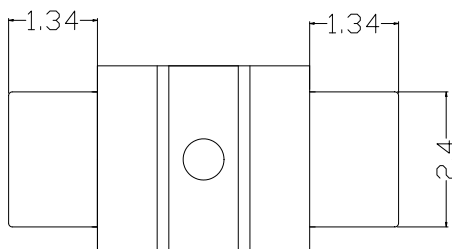

1-3 Bottom view 背视图



1-2 Side view 侧视图

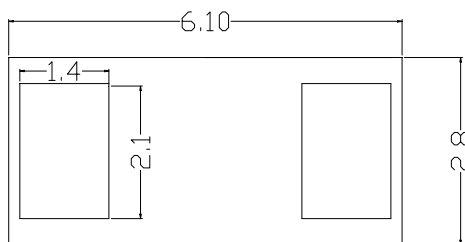

1-4 Soldering patterns 推荐焊盘

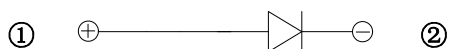

1-5 Polarity 极性

Notes (备注):

1. All dimensions are in millimeters (所有标注尺寸单位为毫米)
2. Tolerances are $\pm 0.15\text{mm}$ unless otherwise noted (除特别标注外, 允许公差为 $\pm 0.15\text{mm}$)

Product Number Explanation (产品编码说明)

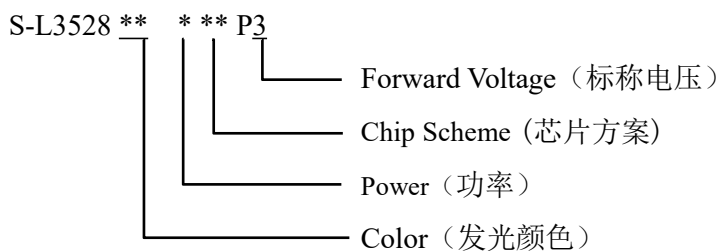

Table of Color (发光颜色)

Symbol (符号)	Color (颜色)
R	Red (单色红光)
G	Green (单色绿光)
WB	Whit Blue (冰蓝光)
PR	Whit pink (粉红光)
Y	Whit yellow (黄光)
PV	Whit violet (紫罗兰)

Table of Power(功率)

Symbol (符号)	Description (描述)
S	0.1W
E	0.2W
R	0.5W
N	1W
T	1.5W

Table of Specifications (规格表)

NO.	P/N	Model	Color	Rendering Wavelength	Min. Luminous Flux
1	/	Z-L3528RS01P3	R	620-630	50 mcd
2	/	Z-L3528GS01P3	G	520-530	400 mcd
3	/	Z-L3528WBS02P3	WB	/	600 mcd
4	/	Z-L3528PRS01P3	PR	/	400 mcd
5	/	Z-L3528YS02P3	Y	575-580	700 mcd
6	/	Z-L3528PVS01P3	PV	/	200 mcd

**Absolute maximum ratings @ T_a=25°C** (绝对最大额定值)

Item (项目)	Symbol (符号)	Absolute Maximum Rating (数值)	Unit (单位)
Forward Current (正向电流)	I _F	5	mA
Pulse Forward Current (脉冲正向电流)	I _{FP}	100	mA
Reverse Voltage (反向电压)	V _R	5	V
Power Dissipation (功率消耗)	P _D	80	mW
Operating Temperature (工作温度)	T _{opr}	-40~+85	°C
Storage Temperature (储存温度)	T _{stg}	-40~+100	°C
Junction Temperature (结温)	T _J	105	°C
Thermal Resistance (热阻)	R _{th}	30	°C/W
Electrostatic Discharge (静电)	ESD	2000 (HBM)	V
Solder Joint Temperature (焊点推荐温度)	T _{sp}	85	°C

Electrical-Optical characteristics @T_a=25°C (电性与光学特性)

Item (项目)	Symbol (符号)	Code (代码)	Test Condition (测试条件)	Min (最小)	Typ (平均)	Max (最大)	Unit (单位)
Forward Voltage (正向电压)	VF	R	IF=5mA	1.8	-	2.4	V
		G	IF=5mA	2.4	-	2.8	V
		WB/PR/Y/PV	IF=5mA	2.4	-	2.8	V
Luminous Flux (亮度)	IV	R	IF=5mA	50	-	200	mcd
		G	IF=5mA	400	-	800	mcd
		WB	IF=5mA	600	-	900	mcd
		PR	IF=5mA	400	-	700	mcd
		Y	IF=5mA	700	-	1000	mcd
		PV	IF=5mA	200	-	500	mcd
		Peak Wavelength (峰值波长)	WLD	R	IF=5mA	620	-
G	IF=5mA			520	-	530	nm
WB	IF=5mA			-	-	-	nm
PR	IF=5mA			-	-	-	nm
Y	IF=5mA			575	-	580	nm
PV	IF=5mA			-	-	-	nm
Reverse Current (反向电压)	IR	-	VR=5V	-	-	1	μA
View Angle (角度)	2θ _{1/2}	-	IF=5mA	-	120	-	deg
CIE Chromaticity (色坐标)	x	/	IF=5mA	Please see the bin sorting standard			
	y	/					

Notes (备注):

1. Tolerance of Forward voltage (VF) : $\pm 0.1V$
正向电压允许公差: $\pm 0.1V$
2. Tolerance of Light intensity (ϕ_v) : $\pm 3\%$
亮度允许公差: $\pm 3\%$
3. Tolerance of Wavelength (WLD) : $\pm 1nm$
波长允许公差: $\pm 1nm$

Luminous Intensity Rank @ $T_a=25^\circ C$ (亮度等级)

Model	Min.	Max.	Unit	Condition
Z-L3528RS01P3	50	200	mcd	$I_F=5mA$
Z-L3528GS01P3	400	800		
Z-L3528WBS02P3	600	900		
Z-L3528PRS01P3	400	700		
Z-L3528YS02P3	700	1000		
Z-L3528PVS01P3	200	500		

Forward Voltage Rank @ $T_a=25^\circ C$ (电压等级)

NO.	Min.	Max.	Unit	Condition
Z-L3528RS01P3	1.8	2.4	V	$I_F=5mA$
Z-L3528GS01P3	2.4	2.8		
Z-L3528WBS02P3	2.4	2.8		
Z-L3528PRS01P3	2.4	2.8		
Z-L3528YS02P3	2.4	2.8		
Z-L3528PVS01P3	2.4	2.8		

Wavelength Rank @ $T_a=25^\circ C$ (波长等级)

NO.	Min.	Max.	Unit	Condition
Z-L3528RS01P3	620	630	nm	$I_F=5mA$
Z-L3528GS01P3	520	530		
Z-L3528WBS02P3	-	-		
Z-L3528PRS01P3	-	-		
Z-L3528YS02P3	575	580		
Z-L3528PVS01P3	-	-		

CIE Chromaticity Diagram @ $I_F=60mA, T_a=25^\circ C$ (色区图)

按客样实际色坐标对色制样

Notes (注释): 1. Main color BIN 主色区

Typical optical characteristics curves @ $T_a=25^{\circ}\text{C}$ (典型光学特性曲线)

Relative Luminous Intensity VS. Forward Current
正向电流与亮度特性曲线

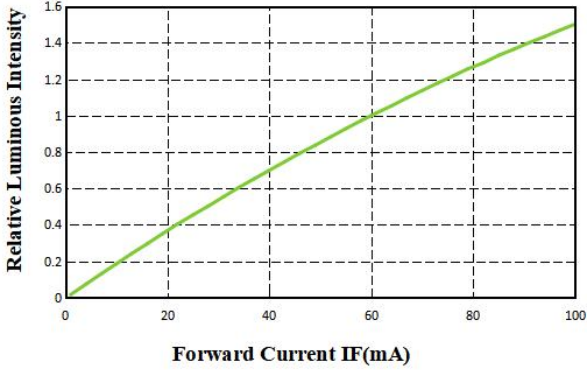

Forward Current VS. Forward Voltage
正向电压与正向电流特性曲线

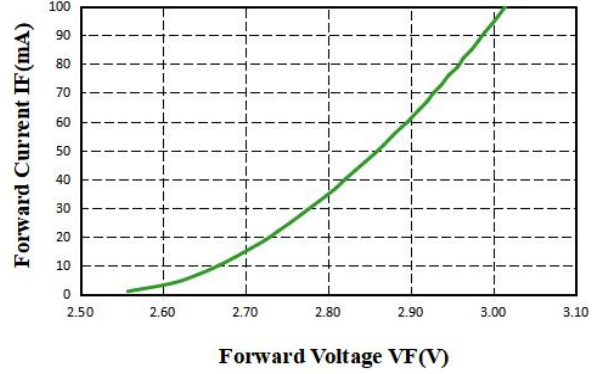

Ambient Temperature VS. Relative Intensity
环境温度与相对光强特性曲线

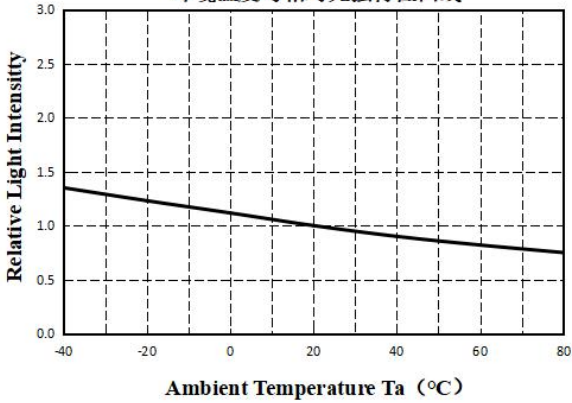

Ambient Temperature VS. Forward Current
环境温度与正向电流的曲线关系

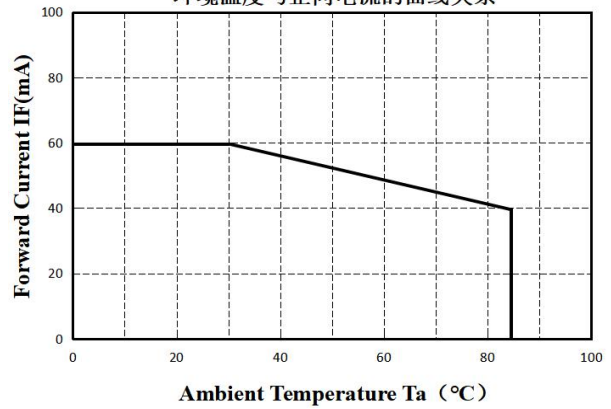

Radiation diagram
辐射图特性曲线

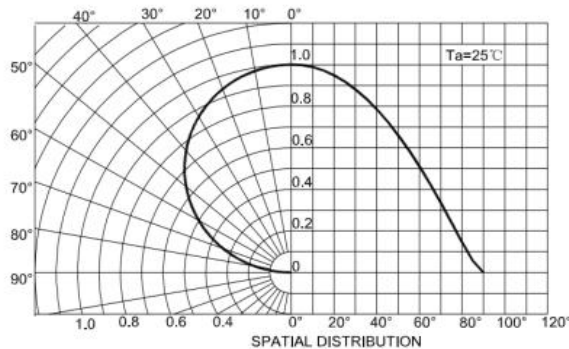

Reliability Test Items And Conditions (信赖性测试项目及条件)

Test Item (项目)	Ref.Standard (参考标准)	Test Conditions (测试条件)	Time (时间)	Quantity (pcs) (数量)
High Temperature Storage (高温储存)	JESD22-A103	Temp:100°C±5°C	1000 hrs	22
Low Temperature Storage (低温储存)	JESD22-A119	Temp:-40°C±5°C	1000 hrs	22
Thermal Shock (冷热冲击)	JESD22-A104	100°C±5°C 30min ↓↑15S -40°C±5°C 30min	200 cycle	22
Reflow (回流焊)	JESD22-B106	Temp:max260°C Time:10sec 8min/cycle	3 cycle	22
Life Test (常温老化)	JESD22-A108	Ta=25°C±5°C I _F =10mA	1000 hrs	22
High Temperature Life Test (高温老化)	JESD22-A108	Ta=85°C±5°C I _F =10mA	1000 hrs	22
High Temperature High Humidity Life Test (高温高湿老化)	JESD22-A101	85°C±5°C/85%RH I _F =10mA	1000 hrs	22

Criteria For Judging Damage (失效判定标准)

Item (项目)	Symbol (符号)	Test Conditions (测试条件)	Criteria for Judgement (判定标准)	
			Min. (最小)	Max. (最大)
Forward Voltage (正向电压)	VF	I _F =10mA	—	(U.S.L*) × 1.1
Light Intensity (光强)	ΦV	I _F =10mA	(L.S.L*) × 0.7	—

Note (备注):

U.S.L.:Upper Standard Level (规格上限)

L.S.L.:Lower Standard Level (规格下限)

Label Explanation (标签说明)

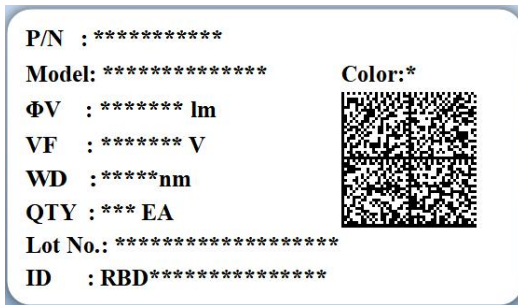

P/N:Part number (产品料号)

Model:Product model (产品型号)

ΦV:Light Intensity rank (光强)

VF:Forward Voltage (电压)

WD:Wavelength (波长)

QTY:Number of packages (数量)

Lot NO.:Lot number (批号)

ID:Identification (标识号)

Color:发光颜色

Reel Dimensions (卷盘尺寸)

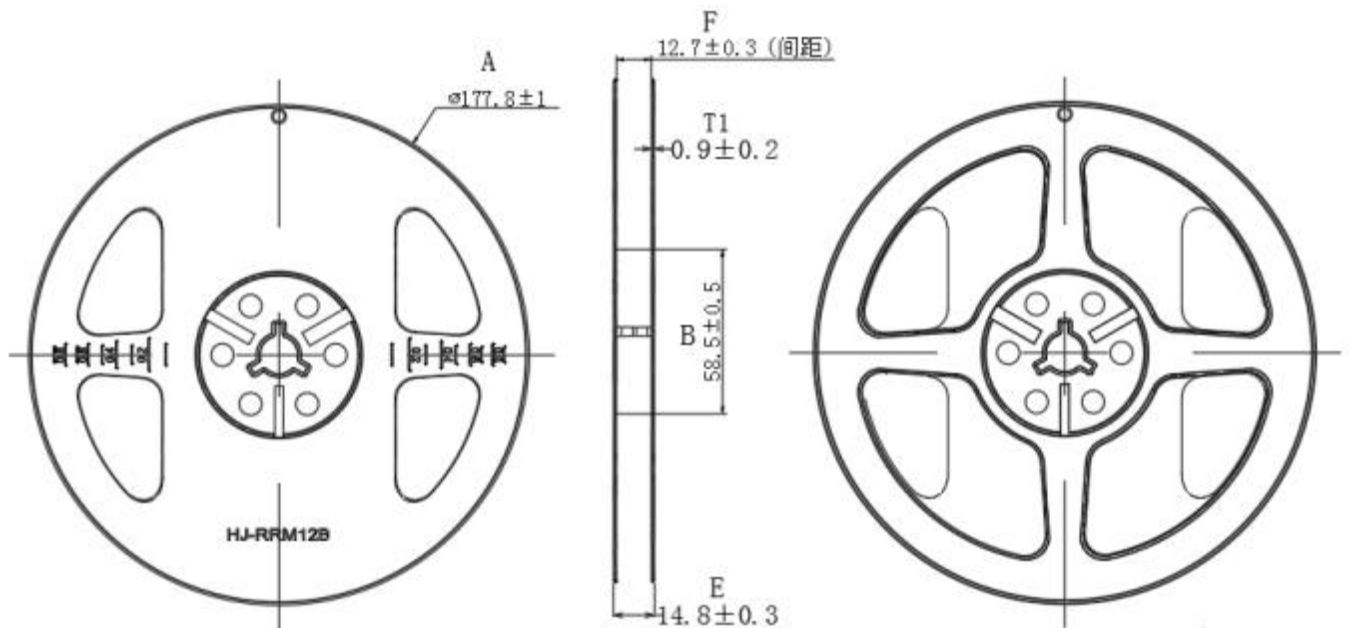

Note (备注):

1. Tolerance unless mentioned is $\pm 0.3\text{mm}$; unit=mm
未标注公差为 $\pm 0.3\text{mm}$, 尺寸单位: mm

Carrier Tape Dimensions (载带尺寸)

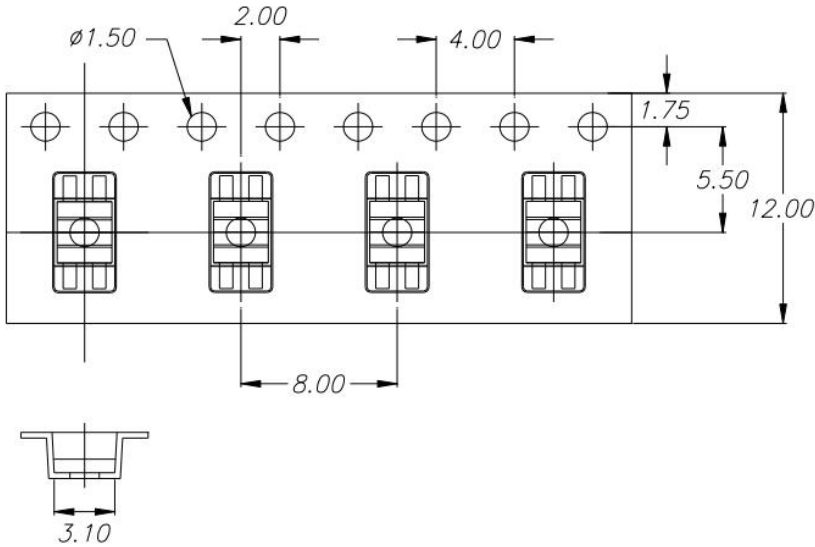

Note (备注) :

1. Tolerance unless mentioned is $\pm 0.1\text{mm}$; unit=mm.
允许公差为 $\pm 0.1\text{mm}$, 单位 mm

Moisture Resistant Packing Process (防潮包装过程)

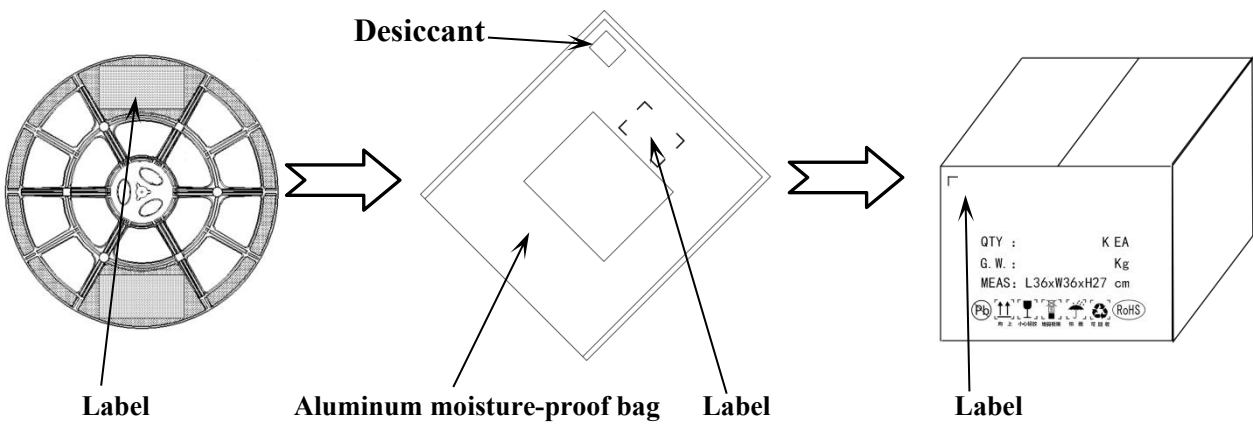

Note (备注) :

1. The cathode is oriented towards the tape sprocket hole in accordance with ANSI/ELARS-481 specifications
负极朝向定位孔, 符合 ANSI/ELARS-481 规格。

Precautions for use Over-current-proof (通电使用时的注意事项)

Customer must apply resistors for protection otherwise slight voltage shift will cause big current change (burn out will happen) .

客户必须使用电阻进行保护, 否则轻微的电压变化会引起大电流变化 (会发生烧坏) 。

Storage (存储)

1. Do not open moisture proof bag before the products are ready to use.
在使用之前禁止打开防潮包装。
2. Storage conditions prior to uncapping : 5 - 30 °C , maximum relative humidity of 60%.
开封前的贮藏条件: 5-30°C, 最大相对湿度为 60%。
3. After opening the package, The LEDs should be soldered within 4 hours after opening the package.
打开包装之后,应在 4hrs 内焊接完毕。

Soldering Condition (焊接条件)

1. Number of reflow process shall be less than 2 times and cooling process to normal temperature is required between first and Second soldering process.
本产品最多只可回流焊两次,且在首次回焊后须冷却至室温之后方可进行第二次回流焊。
2. Recommended soldering conditions:
推荐焊接条件:

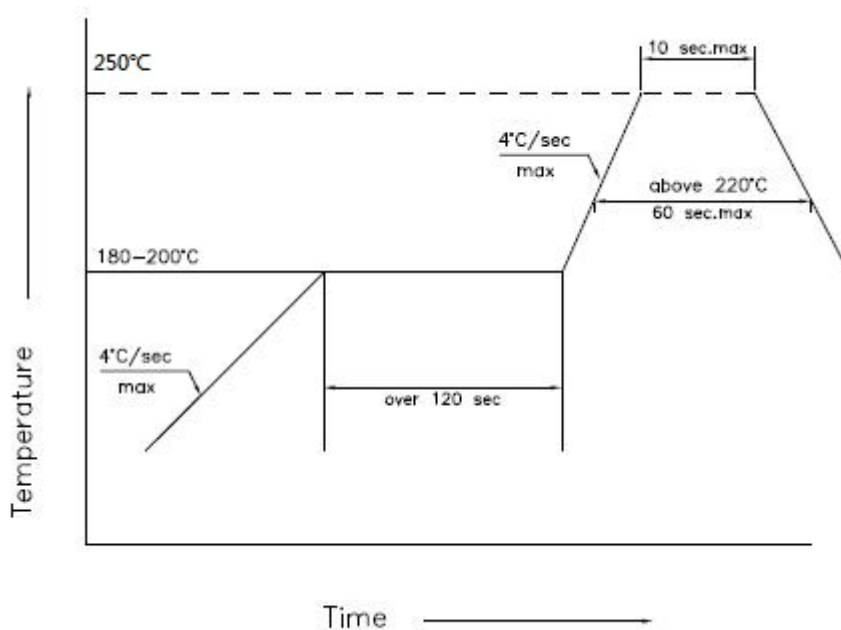

3. LED operating environment and sulfur element composition cannot be over 25 PPM in the LED mating usage material.
LED 工作环境及与 LED 适配的材料中硫元素及化合物成份不可超过 25PPM。

Soldering Iron (烙铁焊接)

1. When hand soldering, keep the temperature of iron below less 250°C less than 10 seconds.
当手工焊接时,烙铁的温度必须小于 250°C,时间不可超过 10 秒。
2. The hand solder should be done only one time.
手工焊接只可焊接一次。

Repairing (返修)

Repair should not be done after the LEDs have been soldered. When repairing is unavoidable, a double-head soldering iron should be used (as below figure). It should be confirmed beforehand whether the characteristics of the LEDs will or will not be damaged by repairing.

不应在 LED 焊接后进行修复。当修复不可避免时，应使用（如下图）之类的双头烙铁，应事先确认此种修补方法会不会损坏 LED 本身。

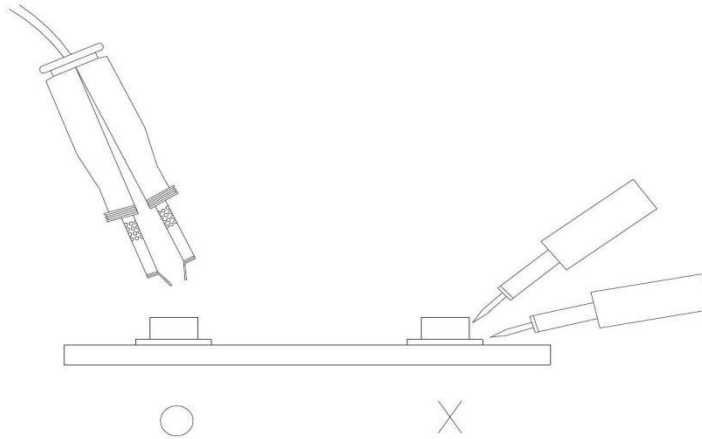

Cautions: (使用注意事项)

1. Please check if there is air leak before opening the package, if so, please return the goods back to take drying process for later using.

在开包装之前，请先检查包装袋有无漏气，如果有漏气现象，请退回我司重新烘烤除湿包装后再使用

2. Products can be used within 6 months after packaging, after that, they must be:

抽真空包装材料未超过 6 个月可正常使用，包装袋开启后,产品必须:

A.Soldered within 4 hrs;

A.在 4hrs 内焊接完毕;

B.Used in the condition: 30°C within and 60%RH below.

B.使用条件需: 温度:30°C 以内, 湿度:60%RH 以下。

3. The vacuum packaging material is not used for more than 6 months after being packaged unless opening the package and take drying our process in 70°C/12H.

抽真空包装材料超过 6 个月未使用，再使用时需重新拆铝箔袋取出烘烤 70°C/12H 除湿后才可使用。